

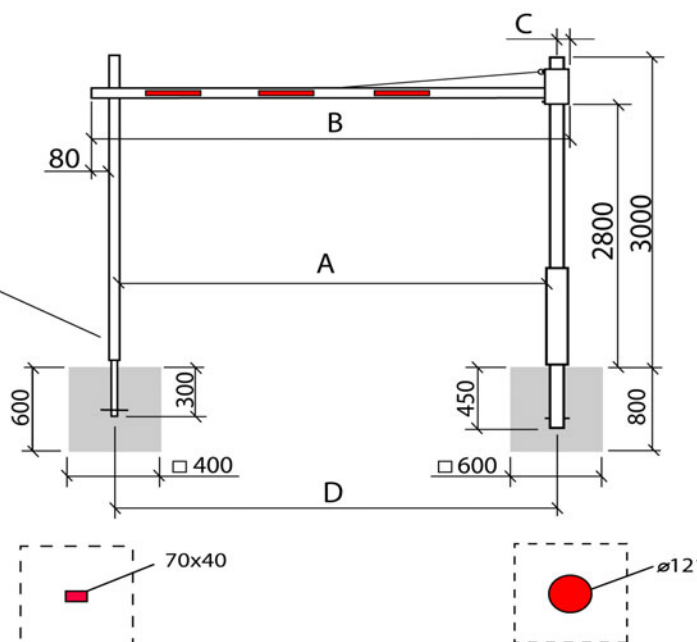

**HBS 50 zum
Einbetonieren**

Fundamentplan

Auflagestütze	Typbreite	A	B	C	D	F
ohne	3000	3.000,00	3.126,00	65	0	6.202,00
mit	3000	2.850,00	3.126,00	65	2.946,00	6.202,00
ohne	3500	3.500,00	3.626,00	65	0	7.202,00
mit	3500	3.350,00	3.626,00	65	3.446,00	7.202,00
ohne	4000	4.000,00	4.126,00	65	0	8.202,00
mit	4000	3.850,00	4.126,00	65	3.946,00	8.202,00
ohne	4500	4.500,00	4.626,00	65	0	9.202,00
mit	4500	4.350,00	4.626,00	65	4.446,00	9.202,00
ohne	5000	5.000,00	5.126,00	65	0	10.202,00
mit	5000	4.850,00	5.126,00	65	4.946,00	10.202,00
ohne	5500	5.500,00	5.626,00	65	0	11.202,00
mit	5500	5.350,00	5.626,00	65	5.446,00	11.202,00
ohne	6000	6.000,00	6.126,00	65	0	12.202,00
mit	6000	5.850,00	6.126,00	65	5.946,00	12.202,00

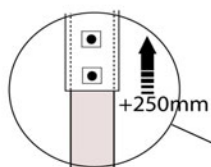
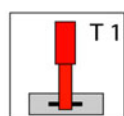

HBS050MZ-1

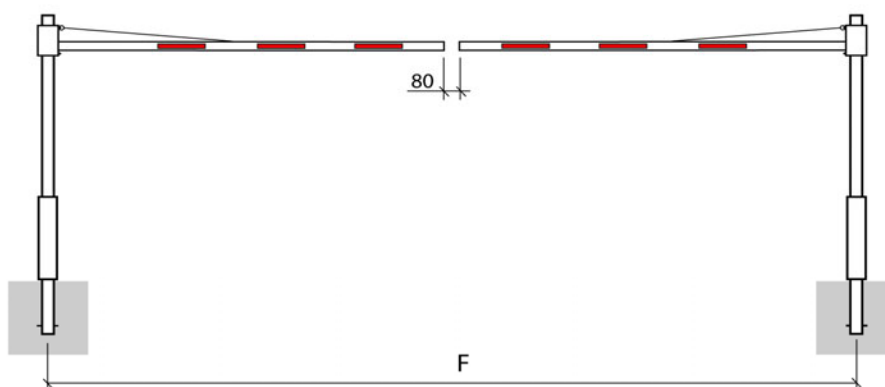

HBS 50 zum
Aufschrauben

Fundamentplan



Auflagestütze	Typbreite	A	B	C	D	F
ohne	3000	2.936,00	3.186,00	125	0	6.202,00
mit	3000	2.696,00	3.125,00	125	2.948,00	6.202,00
ohne	3500	3.436,00	3.686,00	125	0	7.202,00
mit	3500	3.196,00	3.625,00	125	3.448,00	7.202,00
ohne	4000	3.936,00	4.186,00	125	0	8.202,00
mit	4000	3.696,00	4.125,00	125	3.948,00	8.202,00
ohne	4500	4.436,00	4.686,00	125	0	9.202,00
mit	4500	4.196,00	4.625,00	125	4.448,00	9.202,00
ohne	5000	4.936,00	5.186,00	125	0	10.202,00
mit	5000	4.696,00	5.125,00	125	4.948,00	10.202,00
ohne	5500	5.436,00	5.686,00	125	0	11.202,00
mit	5500	5.196,00	5.625,00	125	5.448,00	11.202,00
ohne	6000	5.936,00	6.186,00	125	0	12.202,00
mit	6000	5.696,00	6.125,00	125	5.948,00	12.202,00

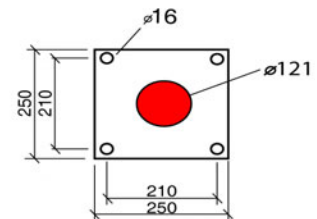
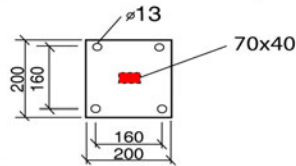
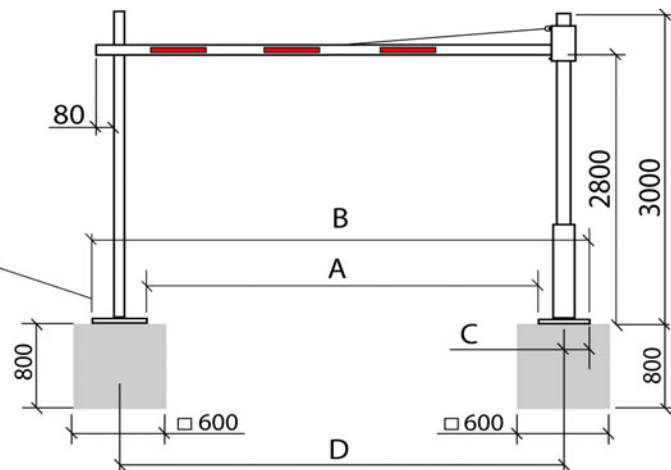
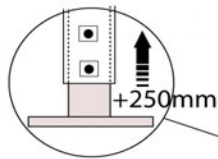
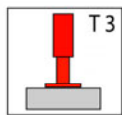

HBS050MZ-3

